



**BEHIND EVERY GREAT MEAL**

# **USER GUIDE**

A commitment to:



**Countries of destination:**

GB - Great Britain

IE - Ireland

DE - Germany

ES - Spain

FR - France

IT - Italy

PL - Poland

NL - Netherlands

SE - Sweden

CN - China

NZ - New Zealand

AU - Australia

To contact Belling about your appliance, please call:



**Customer Care Helpline**

**UK - 0344 815 3746**

**AU - 1300 556 816**

**NZ - 09 274 8265**



**Warranty Registration**

**UK - 0800 952 1068**

**AU - 1300 556 816**

**NZ - 09 274 8265**



To register your appliance online:

**UK - [www.belling.co.uk](http://www.belling.co.uk)**

**AU - [www.glendimplex.com.au](http://www.glendimplex.com.au)**

**NZ - [www.glendimplex.co.nz](http://www.glendimplex.co.nz)**



**Spares Store**

**UK - 0344 815 3745**



To contact us by email:

**UK - [gdhainfo@gdha.com](mailto:gdhainfo@gdha.com)**

**AU - [sales@glendimplex.com.au](mailto:sales@glendimplex.com.au)**

**NZ - [sales@glendimplex.co.nz](mailto:sales@glendimplex.co.nz)**



To register your appliance by mail:

**Please complete the warranty card  
and return to the address supplied**



Alternatively general, spares and service information is available from our website at:

UK - [www.belling.co.uk](http://www.belling.co.uk)

AU - [www.glendimplex.com.au](http://www.glendimplex.com.au)

NZ - [www.glendimplex.co.nz](http://www.glendimplex.co.nz)

Calls are charged at the basic rate, please check with your telephone service provider for exact charges

During the period of guarantee, as specified on your warranty registration card, your appliance is protected against electrical and mechanical breakdown. For UK products, your new appliance comes with our **12-month guarantee** and for AU/NZ appliances, this comes with a **2 year warranty**. To register your appliance, please call the number assigned to your country of purchase, register online or complete the registration card or form included.

Please ensure that you have available your appliance model number and serial number. For full terms & conditions of the manufacturer's guarantee, refer to the website.

Our policy is one of constant development and improvement, therefore we cannot guarantee the strict accuracy of all of our illustrations and specifications. Changes may have been made subsequent to publishing.

**UK** - Glen Dimplex Home Appliances, Stoney Lane, Prescot, Merseyside, L35 2XW

**AU** - Glen Dimplex Australia PTY LTD, 1/21 Lionel Road, Mount Waverley, Victoria 3149, Australia

**NZ** - Glen Dimplex New Zealand Pty, 38 Harris Road, East Tamaki, Auckland, New Zealand

# INTRODUCTION

---

Thank you for buying this British-built appliance from us.

This user guide book is designed to help you through each step of owning your new product.

Please read it carefully before you start using your appliance, as we have endeavored to answer as many questions as possible, and provide you with as much support as we can.

General information, spares and service information is available from our website.

If you should find something missing from your product or have any questions that are not covered in this user guide, please contact us (see contact information inside the front cover).

This unit must be installed by a competent electrician / qualified technician. In regions where applicable, please retain your Certificate of Compliance.

## European Directives

As a producer and a supplier of cooking appliances we are committed to the protection of the environment and are in compliance with the WEEE directive. All our electric products are labelled accordingly with the crossed out wheeled bin symbol. This indicates, for disposal purposes at end of life, that these products must be taken to a recognized collection points, such as local authority sites/local recycling centres.



This appliance Complies with European Community Directives (CE) for household and similar electrical appliances and Gas appliances where applicable.

This appliance conforms to European Directive regarding Eco design requirements for energy-related products. Our policy is one of constant development and improvement, therefore we cannot guarantee the strict accuracy of all of our illustrations and specifications - changes may have been made subsequent to publishing.

## Disposal of Packaging Material

The packaging materials used with this appliance can be recycled. Please dispose of the packaging materials in the appropriate container at your local waste disposal facilities.

### **UK ONLY GAS WARNING:**

If you smell gas, Do not try to light any appliance. Do not touch any electrical switch.  
Call the Gas Emergency Help line at **0800 111999**

# SAFETY

---

## WARNING

- If the hob surface is cracked, broken or shattered, switch off the appliance to avoid the possibility of electric shock and call for a service engineer's visit.
- The appliance and its accessible parts become hot during use. Care should be taken to avoid touching heating elements. Children less than 8 years of age shall be kept away unless continuously supervised. This appliance can be used by children aged from 8 years and above and persons with reduced physical sensory or mental capabilities or lack of experience and knowledge if they have been given supervision or instruction concerning the use of the appliance in a safe way and understand the hazards involved. Children shall not play with the appliance. Cleaning and user maintenance shall not be made by children without supervision.
- Do not use a steam cleaner on any cooking range, hob or oven appliance.
- Metallic objects such as knives, forks, spoons and lids should not be placed on the hob surface since they can get hot.
- After use, switch off the hob element by its control and do not rely on the pan detector.
- The appliance is not intended to be operated by means of an external timer or separate control system.
- Unattended cooking on a hob with fat or oil can be dangerous and may result in fire.
- NEVER try to extinguish a fire with water, but switch off the appliance and then cover the flame with a lid or damp cloth.
- Danger of fire: Do not store items on the cooking surfaces.
- Only use hob guards designed by the manufacturer of the cooking appliance or indicated by the manufacturer of the appliance in the instructions for use as suitable or hob guards incorporated in the appliance. The use of inappropriate hob guards can cause accidents.

## CAUTION

- The cooking process has to be supervised. A short term cooking process has to be supervised continuously.

- **Fire Safety Advice**

If you do have a fire in the kitchen, don't take any risks - get everyone out of your home and call the Fire Brigade.

**If you have an electrical fire in the kitchen:**

- Pull the plug out, or switch off the power at the fuse box - this may be enough to stop the fire immediately
- Smother the fire with a fire blanket, or use a dry powder or carbon dioxide extinguisher
- Remember: never use water on an electrical or cooking oil fire.

- **Other Safety Advice**

- Servicing should be carried out only by authorised personnel.
- There is a risk of electric shock, so always make sure you have turned off and unplugged your appliance before starting. Always allow the product to cool down before you change a bulb.
- This appliance must be earthed.
- The appliance must never be disconnected from the mains supply during use, as this will seriously affect the safety and performance, particularly in relation to surface temperatures becoming hot and gas operated parts not working efficiently.
- **GAS WARNING!** - If you smell gas: Do not try to light any appliance, Do not touch any electrical switch. Contact your local gas supplier immediately.

# USING YOUR APPLIANCE

## Getting to know your product

**Note:** Your appliance layout may differ depending on the model.



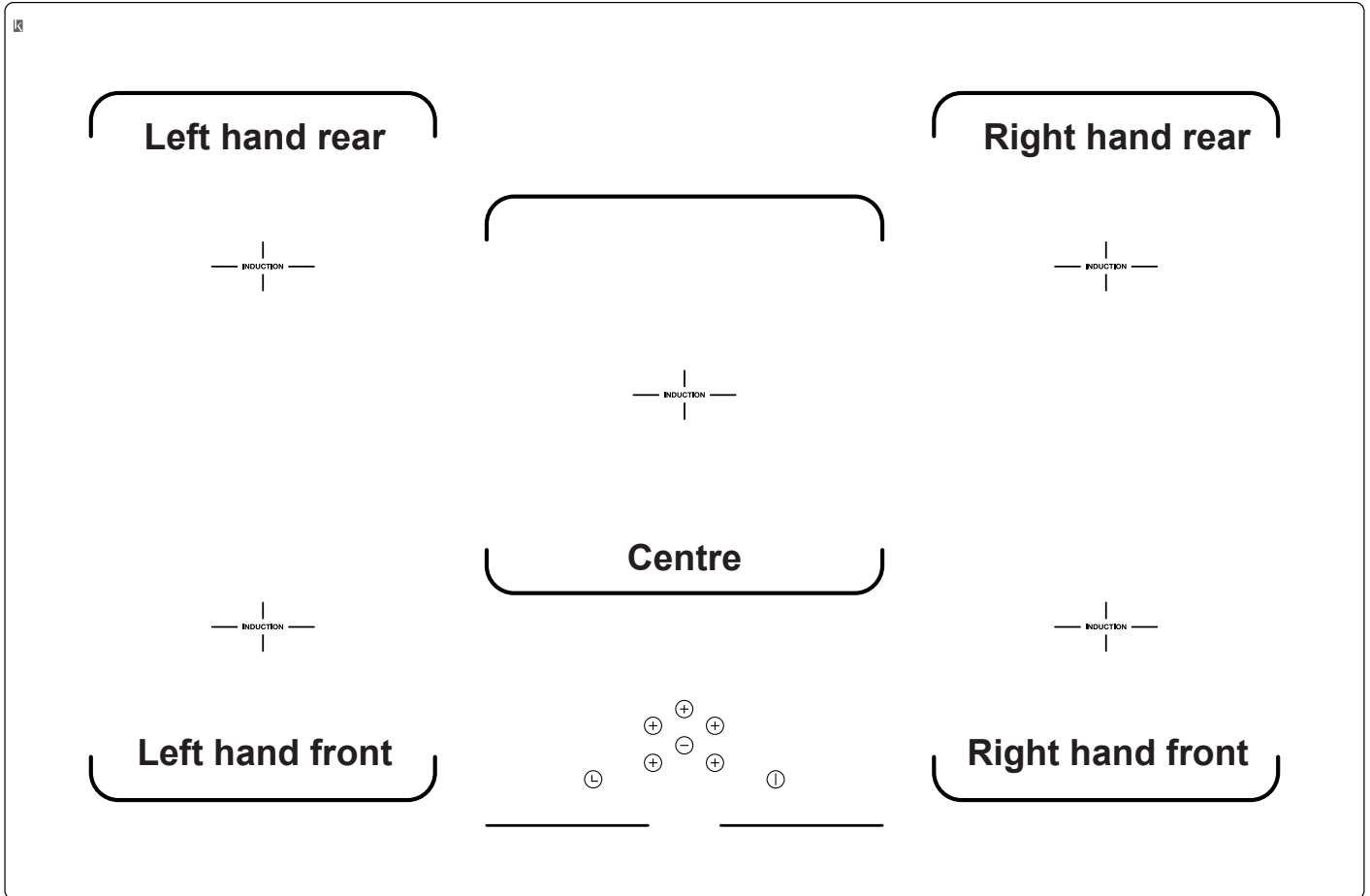



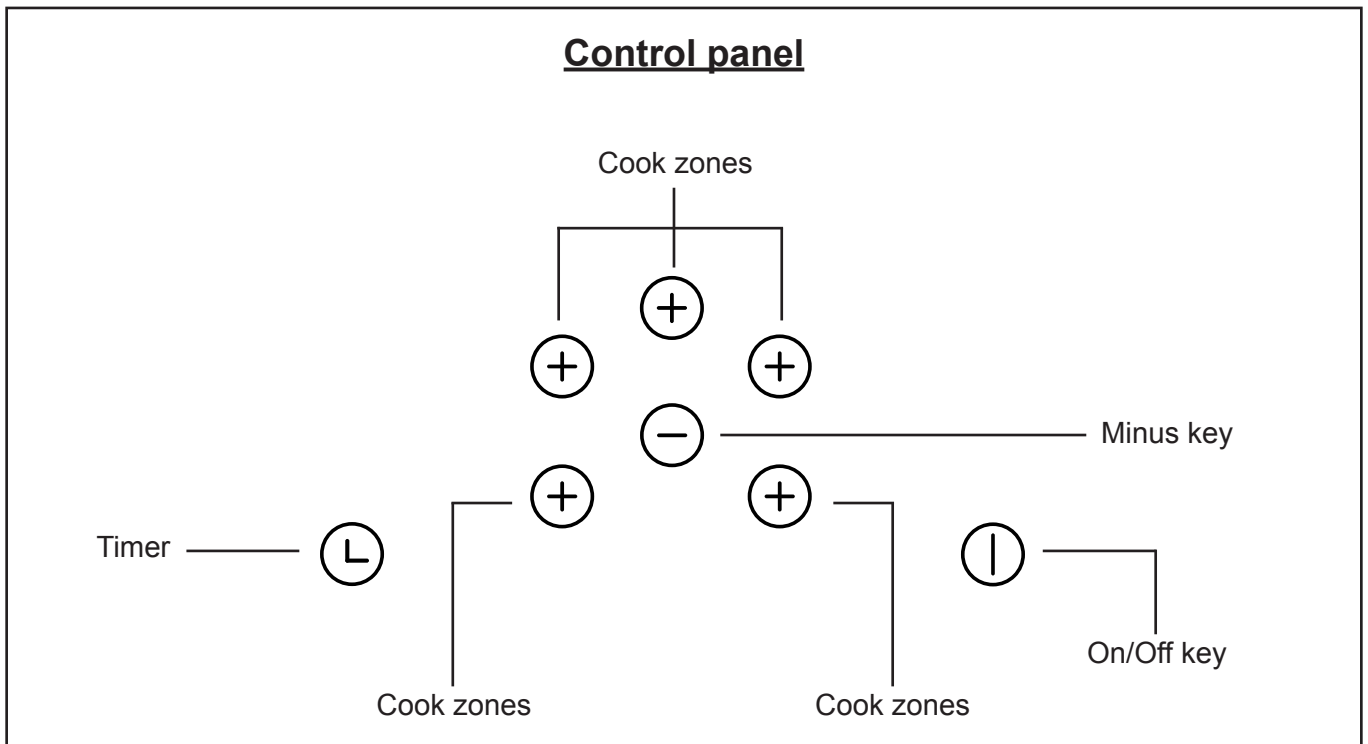

### Hob



### Control panel



# Overview

Function	Description	Symbol
Power Level	Once a cook zone is selected, a power level can be set to a low or high temperature.	1-9
Cook zone timer	Once a cook zone is selected, the cook zone timer can be activated to sound after a pre-determined amount of time. When the alarm sounds, the cook zone will turn off.	
Residual Heat	After use, the cooking surface remains hot and the residual heat symbol will be displayed.	
Automatic switch off	Each cook zone is pre-set with a maximum operation time. Once this time is reached, the zone will automatically switch off. The residual heat symbol will be displayed if the surface remains hot.	N/A
Pan detection	If no pan or an unsuitable pan is detected on an activated cook zone, the pan detection symbol will be displayed. Suitable pans - cast iron, metals with magnetic properties. Non-suitable pans - copper, stainless steel, aluminium, glass, ceramic, terra-cotta.	
Booster function	The booster function temporarily increases the power to a cook zone allowing for a faster heat up time. It will deactivate automatically after 10 minutes or if a lower power level is selected.	
Bridge function	Individual cook zones can be bridged or joined together to create a larger, single controlled cook zone. By bridging the left hand front and rear zones or the right hand front and rear zones, two larger cook zones can be created.	
Pause	When at least one cooking zone is in operation, the pause function can be activated. This will pause all cooking on the hob for up to 10 minutes.	
Recall function	While the hob is in use, if it is accidentally turned off, turn the hob back on within 6 seconds and the settings will be restored.	N/A
Child lock	Child lock can be activated to stop the hob from being accidentally turned on.	
Low temp/keep warm	This setting temperature is set to allows the user to keep food warm without over cooking. This setting can also thaw frozen foods.	

**Caution:** Always ensure that induction pans remain within the marked cooking area when hot. Do not allow hob pans to rest on the user control panel at the front of the hob glass, as this will cause the controls to overheat and the appliance to temporarily shut down.

Please be aware that the pans can make a noise during cooking. This is caused by vibration due to the passage of energy from the hob to the pan.

## Switching the appliance On/Off

**1** Press and hold the On/Off key to activate the appliance

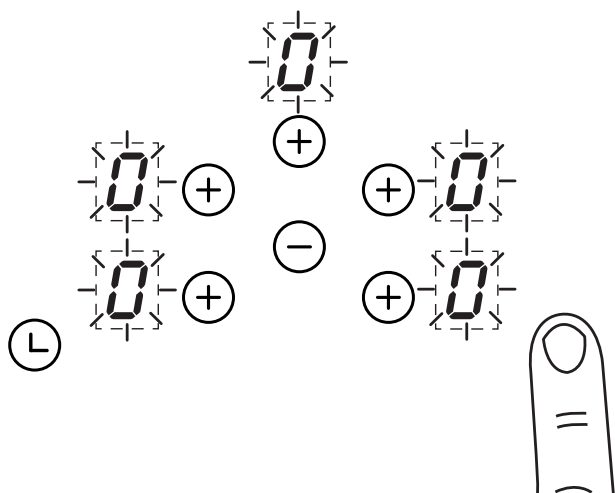

**2** Press and hold the On/Off key to deactivate the appliance

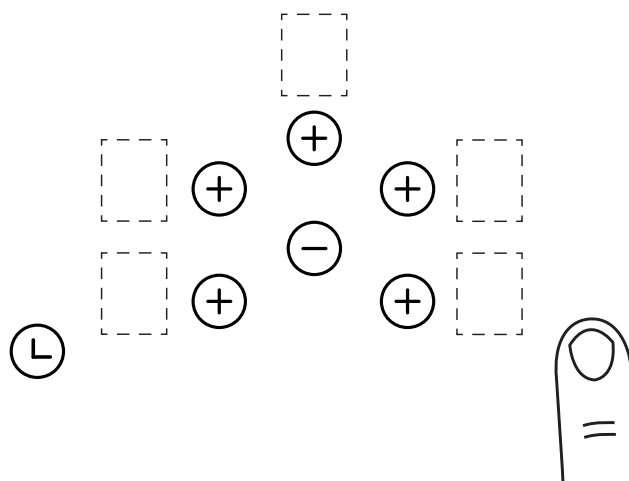

If within 20 seconds, no action (zone or timer selection) takes place the hob will automatically switch off.

## Switching a cook zone On/Off

**1** Touch the plus key for the relevant cook zone

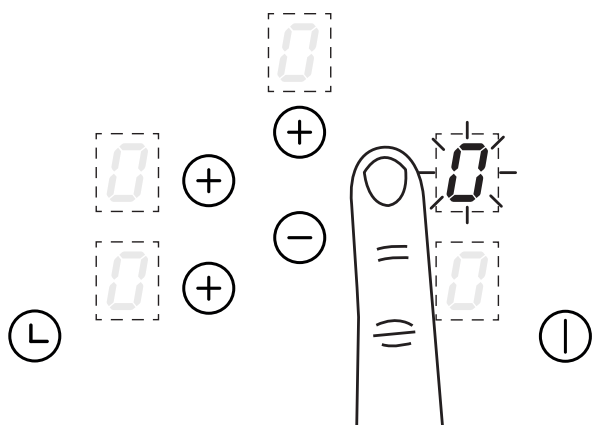

**2** Touch the cook zone plus key and the central minus key to set a power level

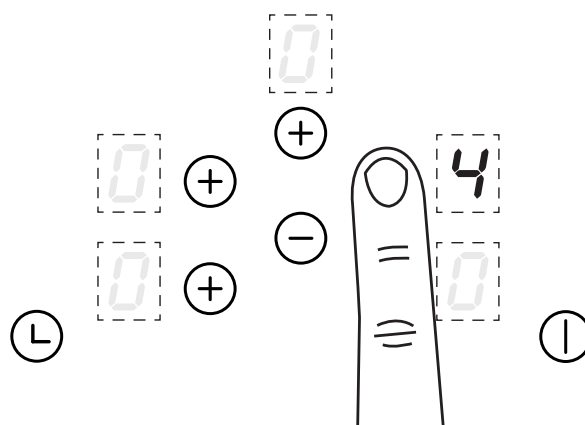

**Note:** Setting the power level to "0" will switch off the cook zone.



# Griddle zone with bridge function

**1** Press the Front Left or Front Right key and hold until the Bridge symbol blinks

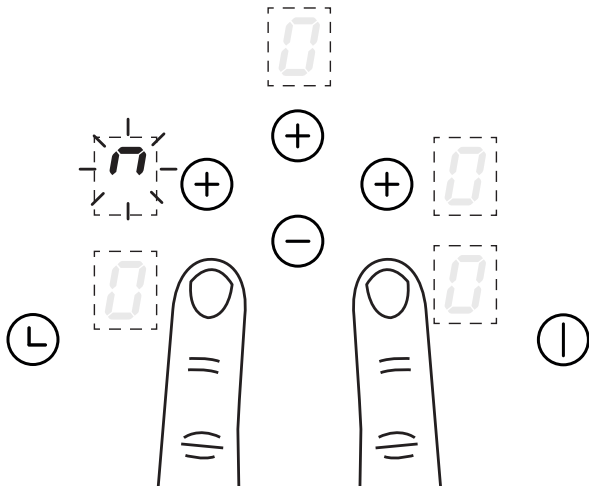

**2** Press the corresponding rear key immediately to activate

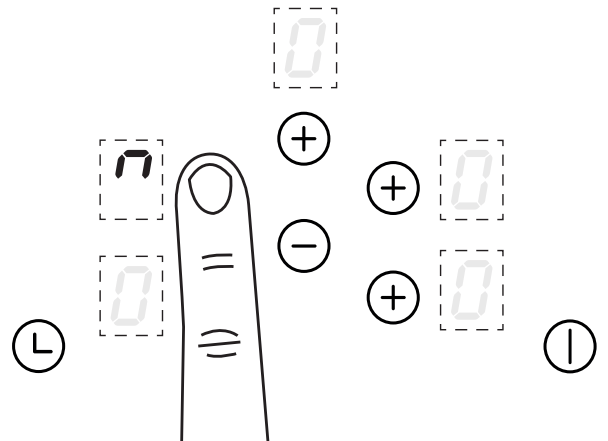

**3** Once activated, set the power level by touching the front zone plus key and central minus key.

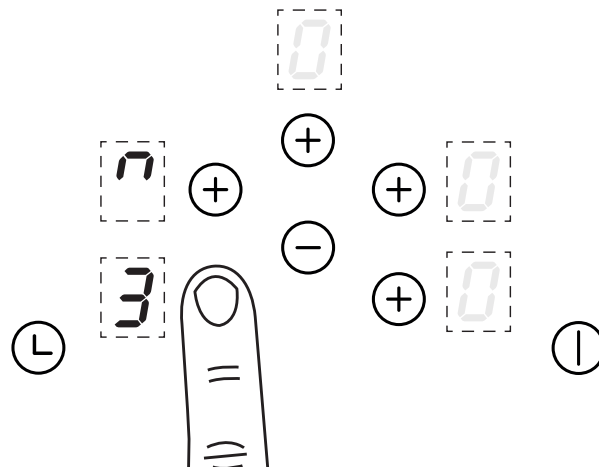

The Left Hand and Right Hand zones can be used as 4 separate cooking zones which can be controlled individually or they can be bridged to provide 2 large zones that can be controlled via one setting on each side. Large pans and griddle plates can be placed across the bridged zones.

## Low temperature setting/Keep warm

**1** Touch the plus key for the relevant cook zone

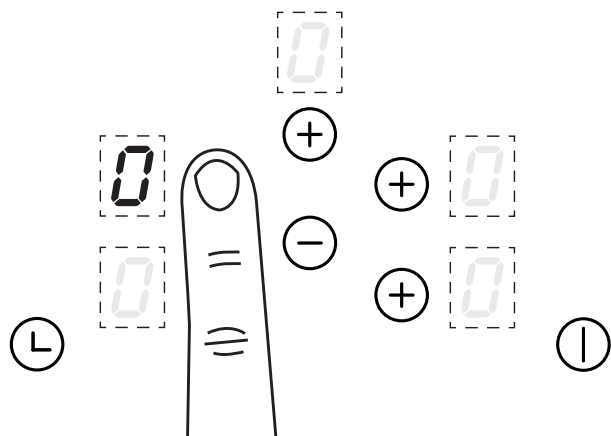

**2** Touch the cook zone plus key to select "u"

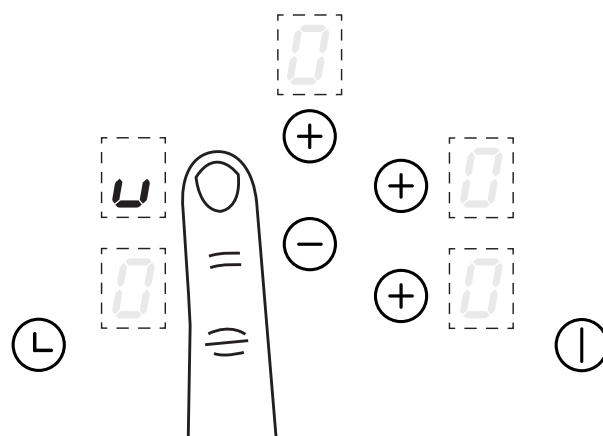

The "u" symbol can be found between power level "0" and "1". Use the relevant cook zone plus key and central minus key to scroll through the power levels.

This function can be used when the cook zone(s) are in the bridge function.

## Pause key

**1** Press and hold central minus key

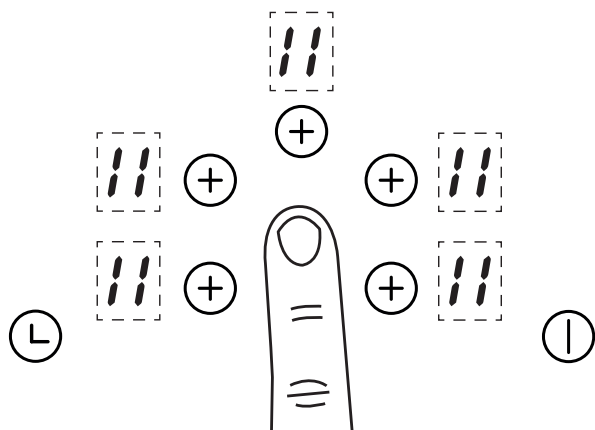

**2** Press and hold central minus key until beep, then immediately press any cook zone plus key to de-activate

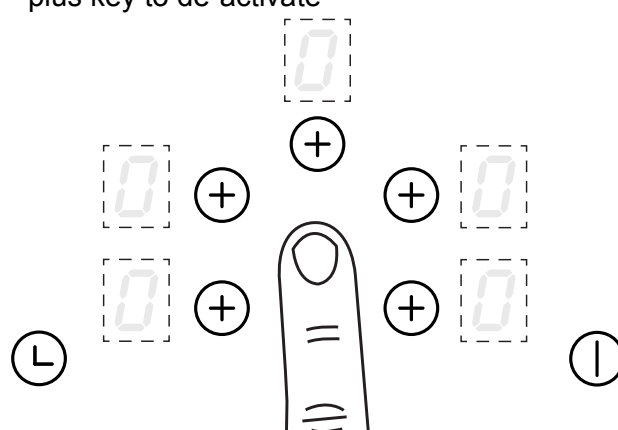

If the pause mode is not de-activated within 10 minutes, the hob will switch off.

## Recall

If the hob is switched off accidentally, all the settings can be restored within 6 seconds by pressing the On/Off key, followed by the central minus key to resume cooking.

# Booster function

**1** Touch the plus key for the relevant cook zone

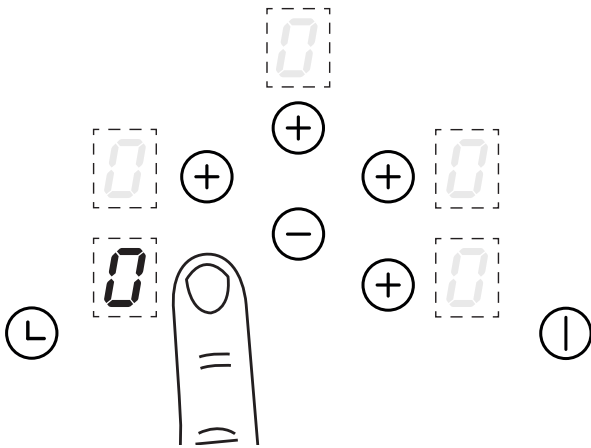

**2** Use the cook zone plus key and the central minus key to select "P"

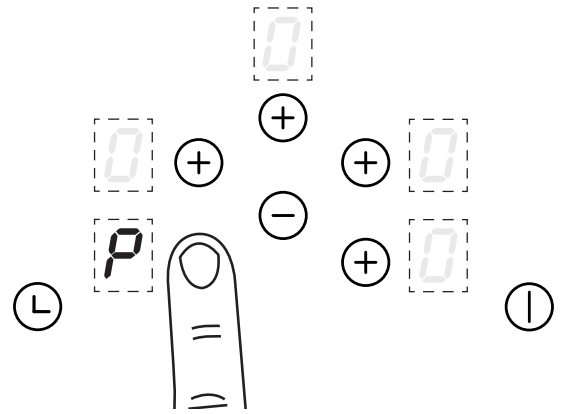

For quick operation, touch the minus key for quicker access to the Power Boost level.

The power boost function can temporarily boost the power to a cook zone. This function is not available in bridge mode.

**Note:** The Power Boost function will only operate for a limited time and will deactivate automatically if the product is hot or overheating.

# Setting the Minute minder

**1** Touch the timer key

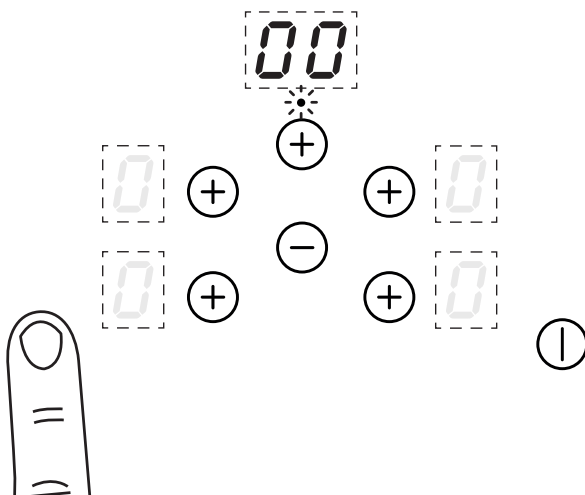

**2** Set the time by pressing the timer key and the minus key

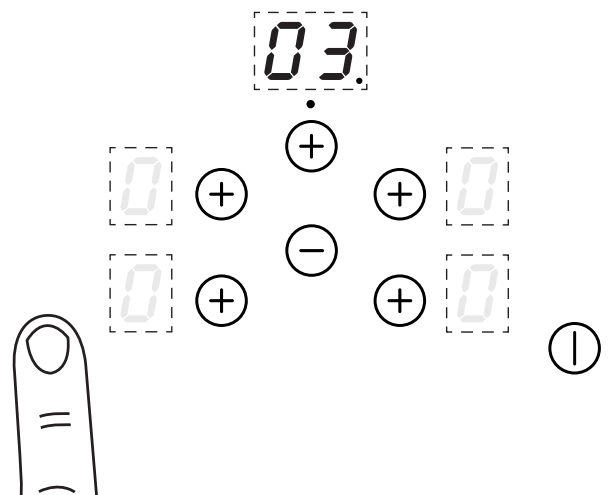

**3** The time will set when no key is pressed after 3 seconds. A dot will flash in the timer display.

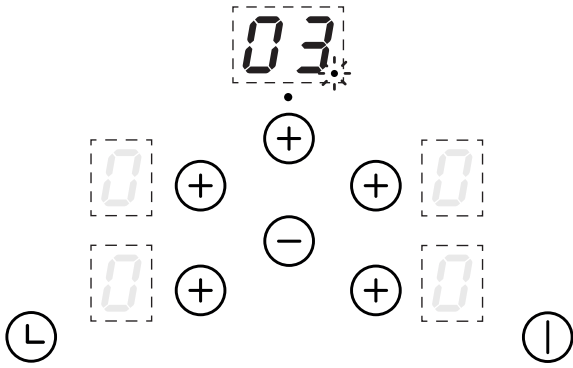

**4** Press any key when the time is up. The timer display will flash and beep will be heard. Touch any key to stop the beeping.

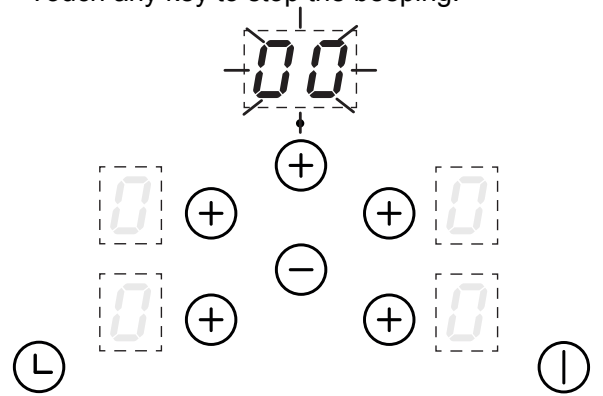

The maximum temperature that can be set is 99 minutes.

## To modify or cancel the Minute minder

Repeat "Setting the Minute minder" steps to modify the timer.

Setting the time back to "00" will cancel the minute minder.

## Timer auto switch off

Ensure power level is already set before selecting a cook zone to be timed.

**1** Touch the cook zone plus key

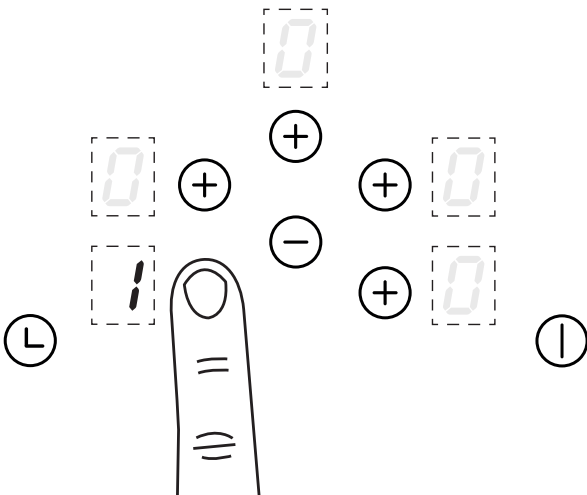

**2** Touch the timer key

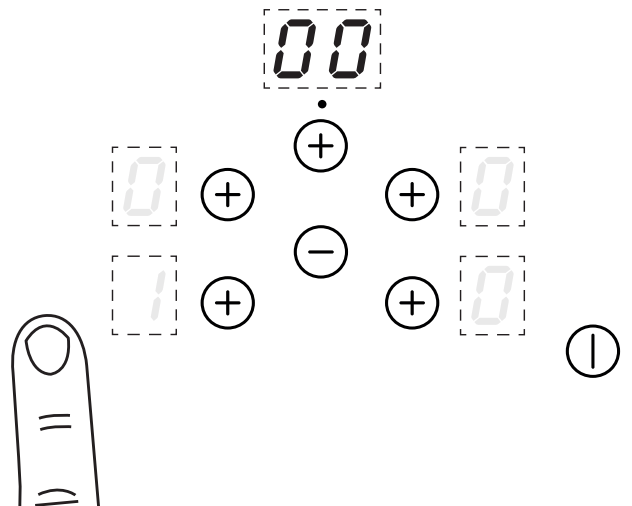

- 3** Set the time by pressing the timer and the minus key. An arrow symbol will appear next to the selected cook zone.

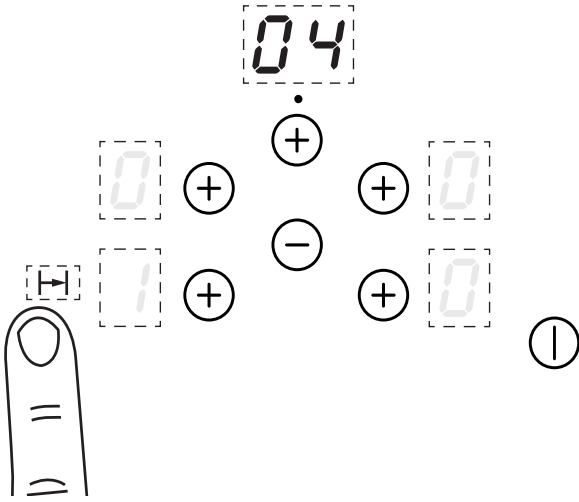

- 4** The time is set when no key is pressed after 3 seconds. An arrow will appear in the timed cook zone.

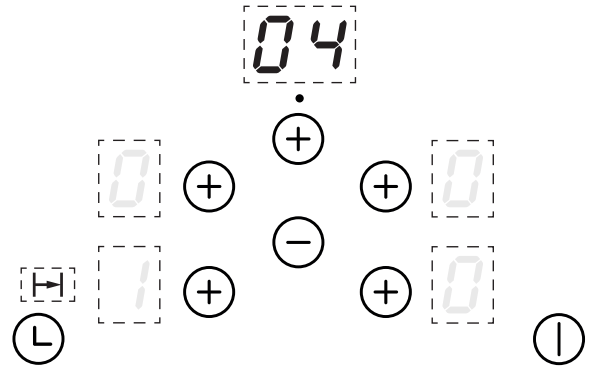

When the time is up, the timer display will flash, beep and the cook zone will automatically switch off. Touch any key to stop the beeping.

## To modify or cancel the Minute minder

Repeat the “Setting a cook zone timer” steps to set a time for other cook zones or modify a set time.

Setting the time back to “00” will cancel the minute minder.

## Additional timer information

If multiple zones have been set for timed operation, the timer display will always display the time for the cook zone with the shortest time remaining. To check the timer setting for a different cook zone, simply select the required cook zone, the remaining time will briefly appear in the timer display.

## To activate child lock

The appliance must be switched on.

- 1** Touch and hold the On/Off key for 3 seconds until the “L” symbol appears on all cook zone displays

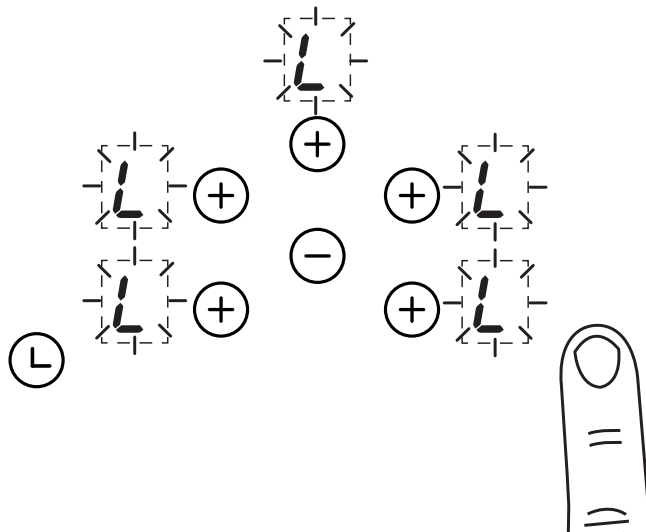

When you now switch on the appliance “L” will appear in all the cook zone displays. The child lock feature will be permanently activated.

## To de-activate the child lock

- 1 Touch and hold the On/Off key to deactivate the child lock. “L” symbol will disappear.

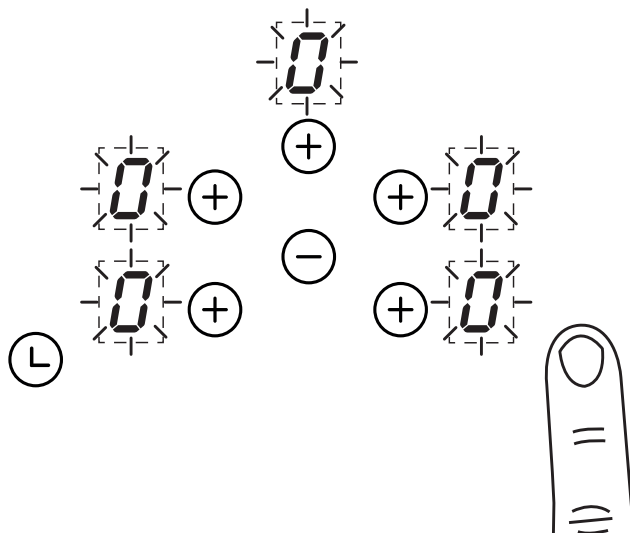

Once the child lock is deactivated, the appliance can continued to be used.

## Hob Status Code

Error code	Description / Fault	Action
L	Cannot operate hob. “L” is displayed on user control	Child lock has been activated, de-activate child lock
N/A	No Power Boost	Allow appliance to cool, power boost will be available when the appliance is cool
ER 21	Hob cuts off after programme setting	The hob has overheated, allow to cool
U400	Appliance not working (connection fault)	Check mains cable connections and terminal blocks are wired correctly
E2	Induction coil overheating	Remove pans and allow to cool
E8	Fan blocked to appliance	Check installation allows for free air flow, clean cooling fan inlets on the underside of the hob
E03	Water or pans on the glass above the user controls	Clean any water on surface above user controls/display

# CLEANING YOUR APPLIANCE

## Do's

**Note:** Always switch off your appliance and allow it to cool down before you clean any part of it.

**Note:** Please take extra care when cleaning over the symbols on the control panel, as this can lead to them fading.

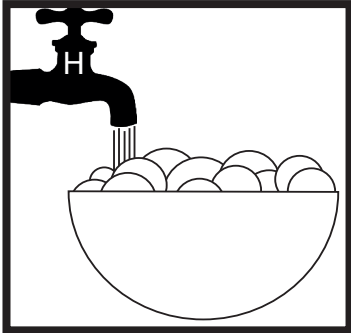

- Warm, soapy water



- Clean, wrung out cloth

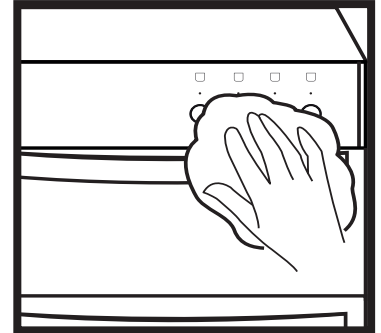

- Wipe with damp cloth
- Dry with a soft cloth

**Tips:** Some foods can mark or damage the metal or paint work e.g.; Vinegar, fruit juices and salt. Always clean food spillages as soon as possible.

## Dont's

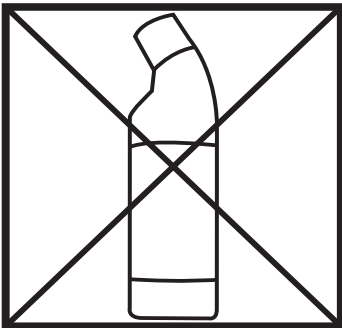

- Undiluted bleaches
- Chloride products

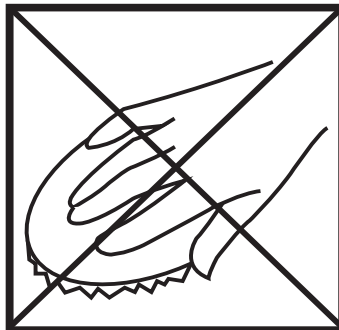

- Wire Wool
- Abrasive cleaners
- Nylon pads
- Steam cleaners

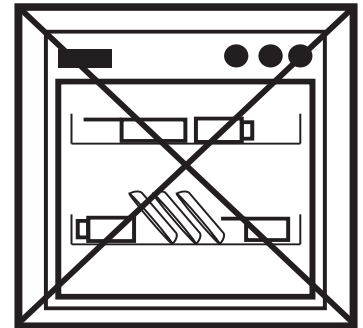

- Do not place in the dishwasher:
- Cast iron griddle
  - Pan supports

**IT IS IMPORTANT TO CLEAN YOUR APPLIANCE REGULARLY AS A BUILD UP OF FAT CAN AFFECT IT'S PERFORMANCE OR DAMAGE IT AND MAY INVALIDATE YOUR GUARANTEE.**

We offer a great range of cleaning products and accessories for your appliance.  
To shop, please visit [www.gdhaonline.co.uk](http://www.gdhaonline.co.uk)

# TECHNICAL DATA

---

## Induction hob

Max. Total Power Rating	
Hob Size (cm)	
80 & 90	220 - 240V ~ 50Hz = 7.4kW

Individual Cook Zone Power Ratings			
Cook Zone	Hob Size (cm)	Normal Power Rating (kW)	Boost Power Rating (kW)
Left Hand Front	80 & 90	1.60	3.00
Left Hand Rear		1.60	3.00
Right Hand Front		1.30	2.90
Right Hand Rear		1.30	2.90
Middle		2.30	3.70

**Note:** If the power boost is selected on the front right hand zone, the rear right hand zone will “Power share” automatically to keep the power used under the allowed limit. This also applies to the left hand side.

## Current table

Induction zone power	Current at 230V	Current at 240V
1.3 kW	5.65 A	5.42 A
1.6 kW	6.96 A	6.67 A
2.3 kW	10 A	9.58 A
2.9 kW	12.61 A	12.08 A
3.0 kW	13.04 A	12.50 A
3.7 kW	16.09 A	15.42 A